



# Remote Meter

---

## User Manual



MT50

EN



# Contents

|                                      |           |
|--------------------------------------|-----------|
| <b>Important Safety Instructions</b> | <b>1</b>  |
| <b>1 General Information</b>         | <b>2</b>  |
| 1.1 Features                         | 2         |
| 1.2 Main functions                   | 2         |
| 1.3 Recommendations                  | 3         |
| <b>2 Installation</b>                | <b>4</b>  |
| <b>3 Product Features</b>            | <b>7</b>  |
| <b>4 Operation</b>                   | <b>12</b> |
| 4.1 Buttons                          | 12        |
| 4.2 Main menu                        | 13        |
| 4.3 Real-time monitoring             | 14        |
| 4.4 Device information               | 16        |
| 4.5 Test operation                   | 16        |
| 4.6 Control parameter                | 17        |
| 4.7 Load setting                     | 24        |
| 4.8 Device parameter                 | 27        |
| 4.9 Device password                  | 28        |

|                                   |           |
|-----------------------------------|-----------|
| 4.10 Factory reset                | 29        |
| 4.11 Failure information          | 29        |
| 4.12 Meter parameter              | 31        |
| <b>5 Technical Specifications</b> | <b>33</b> |
| <b>Appendix Dimensions</b>        | <b>35</b> |

# Important Safety Instructions

## SAVE THESE INSTRUCTIONS:

This manual contains important safety, installation, and operating instructions for the Remote Meter.

## General safety information

- Please inspect the MT50 thoroughly after it is delivered. If any damage is seen, please notify the shipping company or our company immediately. A photo of the damage may be helpful.
- Read all instructions and cautions in the manual before starting the installation.
- Keep the MT50 away from rain, exposure, severe dust, vibrations, corrosive gas, and intense electromagnetic interference.
- Do not allow water to enter the remote meter.
- There are no user-serviceable parts inside the controller. Do not disassemble or attempt to repair it.



**WARNING**

Do not install this product in humid, salt spray, corrosion, greasy, flammable, explosive, dust accumulative, or other severe environments.

# 1 General Information

## 1.1 Features

The MT50 remote meter, using with the controllers designed with RS485 communication, can monitor the controller's real-time working status and program the parameters.

### **Features:**

- Easy to install and operate
- Real-time display of fault alarms
- Locally reading of real-time parameters
- Powered by the controller directly
- Equipped with an RJ45 communication port

## 1.2 Main functions

Functions like real-time monitoring of system data, browsing and modifying related parameters, and restoring factory defaults are based on the LCD and functional key operation.

## 1.3 Recommendations

- **Applicable Models**

| Product series                       | Battery type★                                  | Interface type           | Communication |
|--------------------------------------|--|--------------------------|---------------|
| LS-B, GM-N,<br>VS-BN, Tracer-BN      | Lead-acid battery                              | RJ45                     | RS485         |
| iTracer-AD/ND                        | Lead-acid battery                              | 3.81-4P                  |               |
| Tracer-BP                            | Lead-acid battery                              | RS485<br>waterproof port |               |
| Tracer-AN (10A~40A),<br>TRIRON, XTRA | Lead-acid<br>battery, Lithium<br>battery, User | RJ45                     |               |

★When the MT50 is connected with different devices, the configurable battery types are listed as the above table. For detailed battery types and setting method, refer to chapter [4.6 Control parameter](#).

**Note:** Do not install the MT50 in a situation with strong electromagnetic interference. The MT50 comes standard with an RS485 communication cable (CC-RS485-RS485-200U). If it is connected to a controller that is not a standard RJ45 interface, please purchase an appropriate communication cable in advance.

## 2 Installation

- Frame Mount Dimensions(mm)

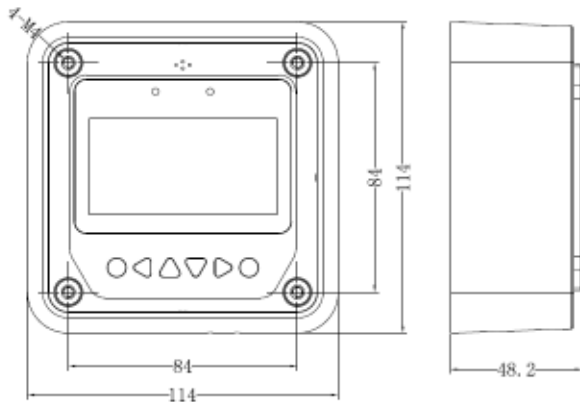

| Mechanical parameter | Parameter          |
|----------------------|--------------------|
| Overall dimension    | 114 x 114 x 48.2mm |
| Mounting dimension   | 84 x 84mm          |
| Terminal             | Φ5                 |



## • Wall mounting

**Step 1:** Locate and drill screw holes based on the frame mounting dimension of the base, and erect the plastic expansion bolts.

**Step 2:** Use four ST4.2×32 self-tapping screws to fix the frame.

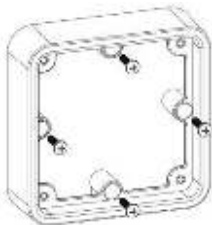

**Step 3:** Use four M4×8 pan head screws to mount the MT50 surface on the frame.

**Step 4:** Mount the four associated screw plugs into the screw holes.



## • Surface mounting

**Step 1:** Locate and drill screw holes based on the installation size of the surface.

**Step 2:** Use four M4×8 cross recessed pan head screws with M4 nuts to mount MT50 Surface onto the panel.

**Step 3:** Mount the four associated white screw plugs into the screw holes.

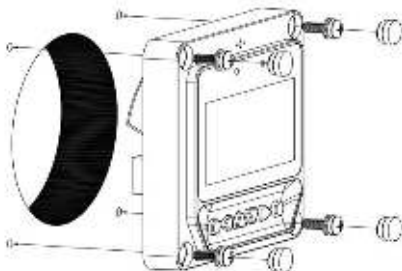

**Note:** Take full consideration of the plugging/unplugging space of the communication cable and the cable's length during installation to see if they are appropriate.

### 3 Product Features

➤ Front view

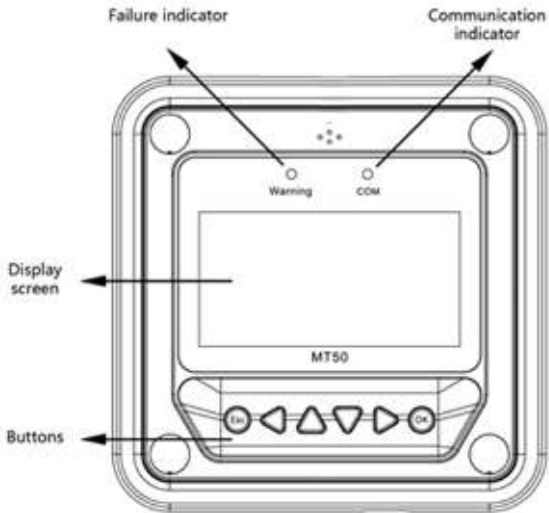

## ➤ Rearview

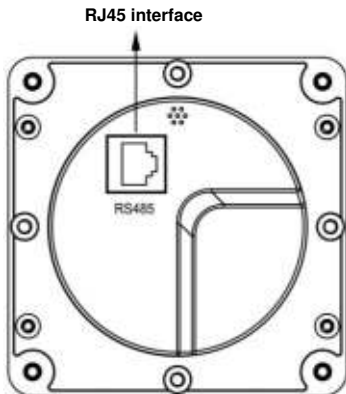









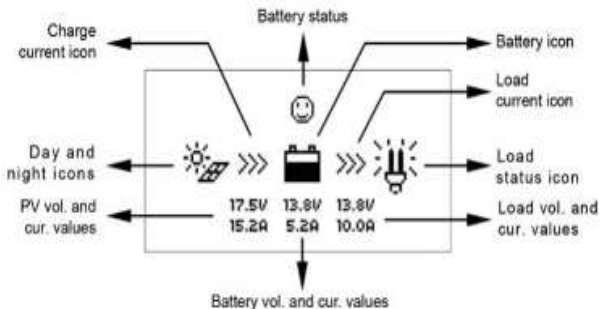

| Module                  | Function  |
|-------------------------|---|
| Failure indicator       | Failure indicator flashes in case of failure of the connected devices. For failure information, please check the Controller Manual. |
| Communication indicator | Indicate communication status when MT50 is connected with the controller.   |
| Display screen          | Man-machine interaction operation interface.  |



|                |  |
|----------------|--|
|                | <b>Note: The display screen can be viewed clearly when the angle between the end-user's horizontal sight and the display screen is within 90°. If the angle exceeds 90°, the information on the display screen cannot be viewed clearly.</b> |
| Buttons        | The Meter buttons include four navigation buttons and two operational buttons. See the specific directions in the Operational Manual.  |
| RJ45 interface | Connect with the controller; it is used for communication and power supply.  |

**Note: Please use the communication plug, marked with "MT," to connect MT50.**

## ➤ Monitoring screen



| Name                 | LCD Display   | Instruction   |
|----------------------|---|---|
| Day and night icons  |  | Night   |
|                      |  | Day<br><b>Note: The threshold voltage is 1V. When it goes higher than 1V, it is daytime.</b>  |
| Charge current icon  |  | The icon is dynamically running if there is a charge current.   |
| Battery icon         |  | The battery capacity is dynamically displayed.<br><b>Note: When the battery is over-discharged, this icon is displayed as ".</b> " |
| Battery status icons |  | Normal voltage  |
|                      |  | Under voltage   |
|                      |  | Over-discharge  |
| Load current icon    |  | The icon is dynamically running if there is a discharge current.  |

|                              |   |  |
|------------------------------|---|--|
| Load status icon             |  | Load On  |
|                              |  | Load Off<br><b>Note: In the Manual Mode, pressing the "OK" button to switch on/off the load.</b> |
| PV vol. and cur. values      | <b>17.5V</b><br><b>15.2A</b>  | Display the PV voltage and current values.   |
| Battery vol. and cur. values | <b>13.8V</b><br><b>5.2A</b>   | Display the battery voltage and current values.  |
| Load vol. and cur. values    | <b>13.8V</b><br><b>10.0A</b>  | Display the load voltage and current values.   |





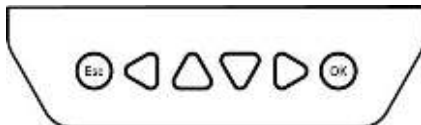

## 4 Operation

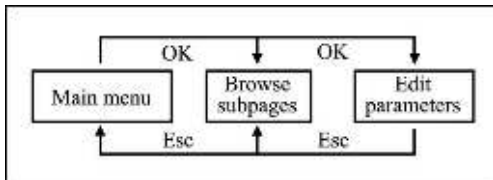
### 4.1 Buttons



The buttons are respectively (from left to right) "ESC," "Left," "Up," "Down," "Right," and "OK "buttons. The operation is described in the schematic operation diagram below:



The default entry page is the browse mode. Press the  button and input the correct password to enter the modification mode.  and  buttons could be used to move the cursor.  and  buttons could be used to modify the parameter values when the cursor is located at the current place.  and  buttons could be finally used to



confirm and cancel the modification of the control parameters.

## 4.2 Main menu

Enter the Main Menu by pressing "Esc." The "Up" and "Down" buttons are respectively used to move the cursor to select the menu items, "OK," and "ESC" buttons are respectively used to enter or exit the corresponding pages of the menu items.

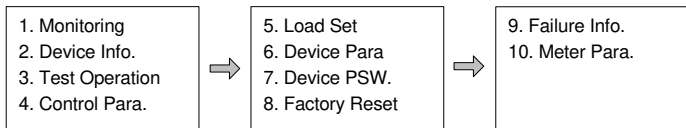



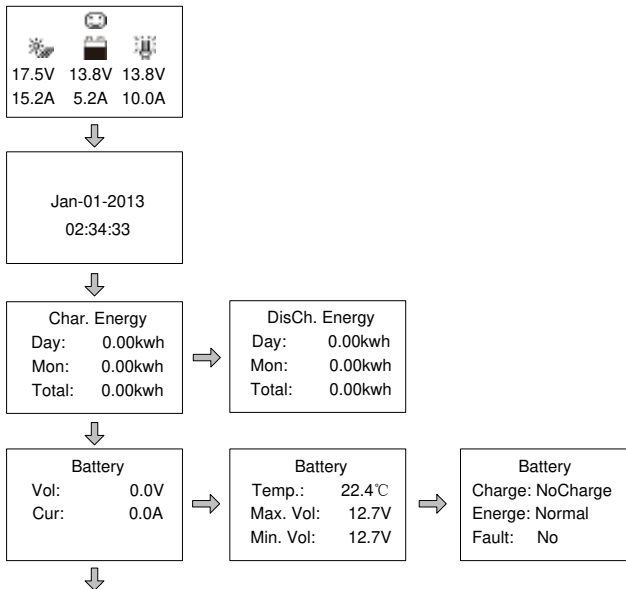

## 4.3 Real-time monitoring

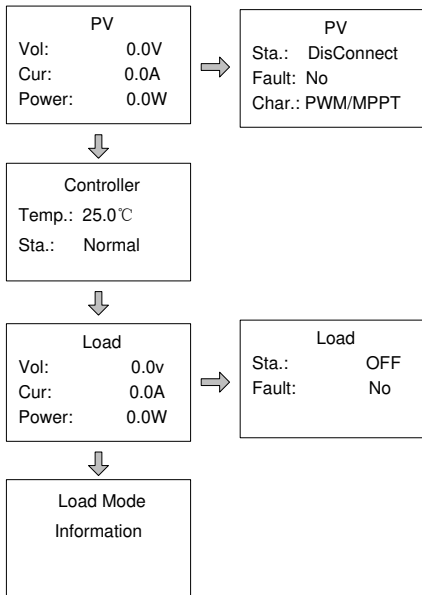
There are 13 pages under real-time monitoring. Please check it as below:







**Operational tips:** Move between rows by pressing the  or  buttons. Move along a row by pressing the  or  buttons.

## 4.4 Device information

The controllers' parameters are displayed below:





|           |       |
|-----------|-------|
| Rate.Vol: | 12V   |
| Char.Cur: | 10.0A |
| Disc.Cur: | 2.6A  |

**Operational tips:**  and  buttons are respectively used to turn the browse page upward and downward.

## 4.5 Test operation

Load switch test operation is conducted on the connection solar controller to see if the load output is normal. The test operation does not affect the working settings under actual load, which means that the solar controller will exit from the test mode when exiting the Test Operation page.

|                |
|----------------|
| Test Operation |
| LS****B: OFF   |

**Operational tips:** Enter the page and input the correct password; use  and  buttons to modify the On/Off status. Press  to confirm and press  to cancel the

test operation.

## 4.6 Control parameter

Browse, and modification operations are conducted over the control parameters of the solar controller. See the scope of parameter modification in the control parameters table and the page of control parameters in the diagram below:

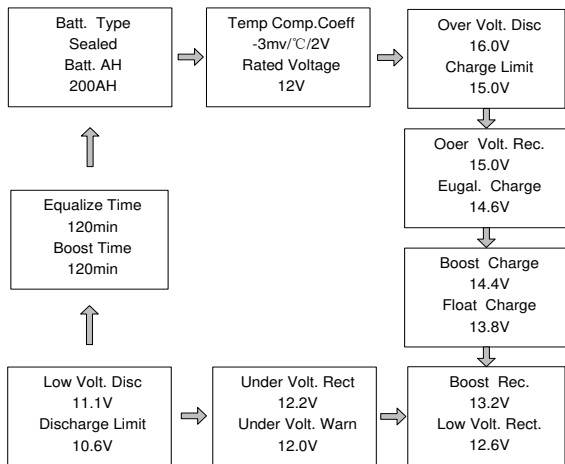

## 1) Batt. Type

Supported battery types are shown as below:

|   |                   |                                   |
|---|-------------------|-----------------------------------|
| 1 | Lead-acid battery | Sealed(default)                   |
|   |                   | Gel                               |
|   |                   | Flooded                           |
| 2 | Lithium battery   | LiFePO4(4S/8S/15S★/16S★)          |
|   |                   | Li(NiCoMn)O2 (3S/6S/7S/13S★/14S★) |
| 3 | User ◆            |                                   |

★ If the controller connected to the MT50 supports 48V system voltage, the battery type will display LiFePO4 15S/16S and Li(NiCoMn)O2 13S/14S.

◆ When switching the battery type to "USE," the default voltage point is the corresponding voltage before the battery type is modified.

## 2) Parameters of the Batt. AH, Temp Comp. Coeff and Rated Voltage

| Parameters                            | Default    | Range                |
|---------------------------------------|------------|----------------------|
| Battery Ah                            | 200Ah      | 1~9999Ah             |
| Temperature compensation coefficient★ | -3mv/°C/2V | 0~-9mv/°C/2V         |
| Rated voltage★                        | Auto       | Auto/12V/24V/36V/48V |

★ When the battery type is selected as the lithium battery (LiFePO4 and

Li(NiCoMn)O<sub>2</sub> series), the "temperature compensation coefficient" and the "rated voltage" cannot be set. The software automatically enables the protection function of "Low temperature prohibits charge and discharge."

### 3) Voltage parameters

- Battery voltage parameters

The below parameters are measured in the condition of 12V/25°C. Please double the values in the 24V system and multiplies the values by 4 in the 48V system.

| Battery charging setting         | Sealed | Gel   | Flooded | User  |
|----------------------------------|--------|-------|---------|-------|
| Over voltage disconnect voltage  | 16.0V  | 16.0V | 16.0V   | 9~17V |
| Charging limit voltage           | 15.0V  | 15.0V | 15.0V   | 9~17V |
| Over voltage reconnect voltage   | 15.0V  | 15.0V | 15.0V   | 9~17V |
| Equalize charging voltage        | 14.6V  | —     | 14.8V   | 9~17V |
| Boost charging voltage           | 14.4V  | 14.2V | 14.6V   | 9~17V |
| Float charging voltage           | 13.8V  | 13.8V | 13.8V   | 9~17V |
| Boost reconnect charging Voltage | 13.2V  | 13.2V | 13.2V   | 9~17V |

|   |        |        |        |           |
|---|--------|--------|--------|-----------|
| Low voltage reconnect voltage           | 12.6V  | 12.6V  | 12.6V  | 9~17V     |
| Under voltage warning reconnect voltage | 12.2V  | 12.2V  | 12.2V  | 9~17V     |
| Under voltage warning voltage           | 12.0V  | 12.0V  | 12.0V  | 9~17V     |
| Low voltage disconnect voltage          | 11.1V  | 11.1V  | 11.1V  | 9~17V     |
| Discharging limit voltage               | 10.6V  | 10.6V  | 10.6V  | 9~17V     |
| Equalize duration                       | 120min | —      | 120min | 0~180min  |
| Boost duration                          | 120min | 120min | 120min | 10~180min |

- **When the battery type is "USE," the battery voltage parameters follow the following logic:**
  - A. Over Voltage Disconnect Voltage > Charging Limit Voltage ≥ Equalize Charging Voltage ≥ Boost Charging Voltage ≥ Float Charging Voltage > Boost Reconnect Charging Voltage.
  - B. Over Voltage Disconnect Voltage > Over Voltage Reconnect Voltage
  - C. Low Voltage Reconnect Voltage > Low Voltage Disconnect Voltage ≥ Discharging Limit Voltage.
  - D. Under Voltage Warning Reconnect Voltage > Under Voltage Warning Voltage ≥ Discharging Limit Voltage;



E. Boost Reconnect Charging voltage >Low Voltage Reconnect Voltage.

● **Lithium Battery voltage parameters**

| Battery type<br>Battery parameters      | LFP    |        |        |        |                   |
|---|--------|--------|--------|--------|-------------------|
|   | LFP4S  | LFP8S  | LFP15S | LFP16S | User <sup>①</sup> |
| Over voltage disconnect voltage         | 14.8V  | 29.6 V | 55.5V  | 59.2V  | 9~17V             |
| Charging limit voltage                  | 14.6 V | 29.2 V | 54.7V  | 58.4V  | 9~17V             |
| Over voltage reconnect voltage          | 14.6 V | 29.2 V | 54.7V  | 58.4V  | 9~17V             |
| Equalize charging voltage               | 14.5 V | 29.0 V | 54.3V  | 58.0V  | 9~17V             |
| Boost charging voltage                  | 14.5 V | 29.0 V | 54.3V  | 58.0V  | 9~17V             |
| Float charging voltage                  | 13.8 V | 27.6 V | 51.7V  | 55.2V  | 9~17V             |
| Boost reconnect charging voltage        | 13.2 V | 26.4 V | 49.5V  | 52.8V  | 9~17V             |
| Low voltage reconnect voltage           | 12.8 V | 25.6 V | 48.0V  | 51.2V  | 9~17V             |
| Under voltage warning reconnect voltage | 12.2 V | 24.4 V | 45.7V  | 48.8V  | 9~17V             |
| Under voltage warning voltage           | 12.0 V | 24.0 V | 45.0V  | 48.0V  | 9~17V             |
| Low voltage disconnect voltage          | 11.1 V | 22.2 V | 41.6V  | 44.4V  | 9~17V             |
| Discharging limit voltage               | 11.0 V | 22.0 V | 41.2V  | 44.0V  | 9~17V             |

① The battery parameters under the "User" battery type is 9-17V for LFP4S. They should x2 for LFP8S and x4 for LFP15S/LFP16S.

| Battery type<br>Battery parameters      | LNCM    |         |         |          |          |                   |
|---|---------|---------|---------|----------|----------|-------------------|
|   | LNCM 3S | LNCM 6S | LNCM 7S | LNCM 13S | LNCM 14S | User <sup>①</sup> |
| Over voltage disconnect voltage         | 12.8 V  | 25.6 V  | 29.8 V  | 55.4V    | 59.7V    | 9~17V             |
| Charging limit voltage                  | 12.6 V  | 25.2 V  | 29.4 V  | 54.6V    | 58.8V    | 9~17V             |
| Over voltage reconnect voltage          | 12.5 V  | 25.0 V  | 29.1 V  | 54.1V    | 58.3V    | 9~17V             |
| Equalize charging voltage               | 12.5 V  | 25.0 V  | 29.1 V  | 54.1V    | 58.3V    | 9~17V             |
| Boost charging voltage                  | 12.5 V  | 25.0 V  | 29.1 V  | 54.1V    | 58.3V    | 9~17V             |
| Float charging voltage                  | 12.2 V  | 24.4 V  | 28.4 V  | 52.8V    | 56.9V    | 9~17V             |
| Boost reconnect charging voltage        | 12.1 V  | 24.2 V  | 28.2 V  | 52.4V    | 56.4V    | 9~17V             |
| Low voltage reconnect voltage           | 10.5 V  | 21.0 V  | 24.5 V  | 45.5V    | 49.0V    | 9~17V             |
| Under voltage warning reconnect voltage | 12.2 V  | 24.4 V  | 28.4 V  | 52.8V    | 56.9V    | 9~17V             |
| Under voltage warning voltage           | 10.5 V  | 21.0 V  | 24.5 V  | 45.5V    | 49.0V    | 9~17V             |

|                                |       |        |        |       |       |       |
|--------------------------------|-------|--------|--------|-------|-------|-------|
| Low voltage disconnect voltage | 9.3 V | 18.6 V | 21.7 V | 40.3V | 43.4V | 9~17V |
| Discharging limit voltage      | 9.3 V | 18.6 V | 21.7 V | 40.3V | 43.4V | 9~17V |

① The battery parameters under the "User" battery type is 9~17V for LFP4S. They should x2 for LFP8S and x4 for LFP15S/LFP16S.

• When the battery type is "USE," the Lithium battery voltage parameters follow the following logic:

- A. Over Voltage Disconnect Voltage > Over Charging Protection Voltage (Protection Circuit Modules (BMS)) + 0.2V;
- B. Over Voltage Disconnect Voltage > Over Voltage Reconnect Voltage = Charging Limit Voltage ≥ Equalize Charging Voltage = Boost Charging Voltage ≥ Float Charging Voltage > Boost Reconnect Charging Voltage;
- C. Low Voltage Reconnect Voltage > Low Voltage Disconnect Voltage ≥ Discharging Limit Voltage.
- D. Under Voltage Warning Reconnect Voltage > Under Voltage Warning Voltage ≥ Discharging Limit Voltage;
- E. Boost Reconnect Charging voltage > Low Voltage Reconnect Voltage;
- F. Low Voltage Disconnect Voltage ≥ Over Discharging Protection Voltage (BMS) + 0.2V



Please refer to the user guide or contact the sales for the details of setting operations.

## 4.7 Load setting

The page of load setting could be used to set the four load working modes of the connection solar controller (Manual, Light on/off, Light on + timer, Time control)

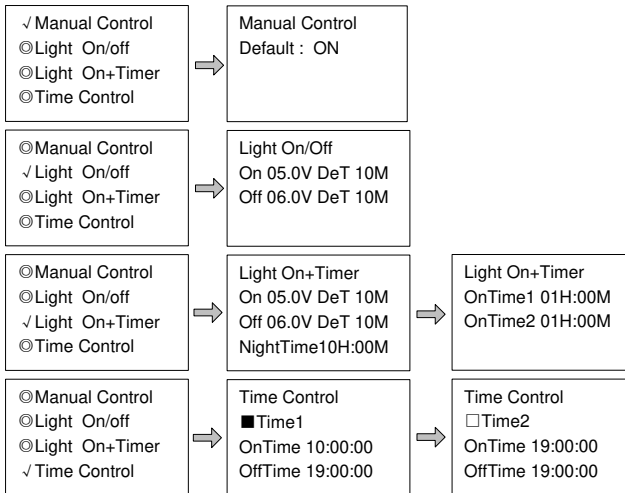

## 1. Manual control

| Mode | Introductions   |
|------|---|
| ON   | The load is on if the battery capacity is enough and no abnormal conditions happen. |
| OFF  | The load is off all the time.   |

## 2. Light On/Off

|                                   |   |
|-----------------------------------|---|
| Light On voltage(Night threshold) | <p>The load output is automatically turned on when the bellows occur at the same time:</p> <ol style="list-style-type: none"><li>1. The solar module's input voltage is lower than the Light On voltage.</li><li>2. The battery capacity is enough.</li><li>3. No abnormal conditions happen.</li></ol> |
| Light Off voltage(Day threshold)  | When the solar module's input voltage is higher than the Light Off voltage, the load output is automatically turned off.  |
| Delay time                        | It means the confirmation time for the light signal. During this period, if the light signal voltage continues matching the Light On/Off voltage, the controller will perform corresponding actions (the time adjustment range: 0~99mins).  |

### 3. Light On+ timer

|                        |   |   |
|------------------------|---|---|
| Working time 1<br>(T1) | Load working period after light control turns on the load     | Any working time is set as "0"; it means this time will stop working. The real working time of T2 depends on the night-time and the length of T1, T2. |
| Working time 2<br>(T2) | Load working period before light control turns off the load   |   |
| Night-time             | Total night-time controller get from calculation( $\geq 3h$ ) |   |

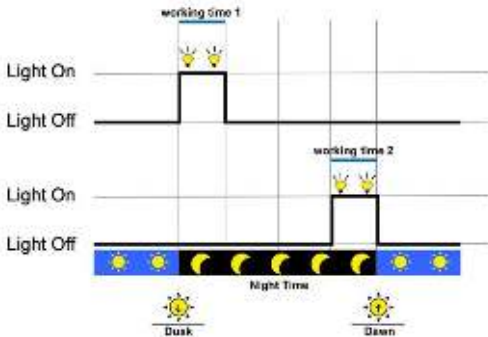

#### 4. Time control

|                      |   |  |
|----------------------|---|--|
| Workingtime1<br>(T1) | Control on/off time of the load through real-time clock mode.                     | Working time 1 is the compulsory load working time interval. Working time 2 is optional. |
| Workingtime2<br>(T2) | Realize the dual timer function of the load control through real-time clock mode. |  |

#### 4.8 Device parameter

The solar controller's software version could be checked via the device parameter page. And device data like device ID, device LCD backlight time, and device clock could also be checked and modified. The device parameter page shows in the diagram below:

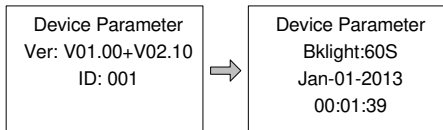

**Note: the bigger the connection device's ID value, the longer the communication identification interval will be (the maximum interval<6 minutes).**

| Type                   | Notes  |
|------------------------|--|
| Ver                    | It indicates the Solar controller's software and hardware version numbers. |
| ID                     | It indicates the Solar controller's communication ID numbers.              |
| Bklight                | It indicates the Solar controller's LCD backlight time.                    |
| Month-Day-Year H: M: S | It indicates the Solar controller's internal clock.                        |

## 4.9 Device password

The solar controller's password could be modified via the device password page. The device password is a 6-digit figure which is required before entering the modification mode of "Control parameter," "Load setting," "Device parameter," "Device password," "Factory reset" pages. The page of the device password in the diagram shows as below:

Device PSW

OriPsw:xxxxxx

NewPsw:xxxxxx

**Note: The default password of the solar charge controller is "000000".**



## 4.10 Factory reset

The solar charger controller's default parameters could be restored via the Factory reset page. Including the "Control parameter," "Load setting," "Charge mode," and "Device password" could all be restored to the factory defaults (the factory default password of the devices is "000000").

|                         |
|-------------------------|
| Factory Reset<br>Yes No |
|-------------------------|

## 4.11 Failure information

The solar controller's failure information could be checked via the Failure information page (a maximum of 15 failure messages could be displayed). After the solar controller's failures are eliminated, the corresponding failure information will also be automatically eliminated.

|  |
|--|
| Failure Info<br>1.Over voltage<br>2.Over load<br>3.Short circuit |
|--|

## Common failure information





| Failure type           | LCD display        | Instructions  |
|------------------------|--------------------|---|
| Charging device status | Load MOS-Short     | The MOSFET of the load driver is short-circuited.                       |
|                        | Load Circuit       | The load circuit is short-circuited.                                    |
|                        | Load O. cur.       | The load circuit is over current.                                       |
|                        | Input O. cur.      | The PV input current exceeds the rated current.                         |
|                        | RPP Short          | The MOSFET of the reverse polarity protection (RPP) is short-circuited. |
|                        | RPP Break          | The MOSFET of the reverse polarity protection (RPP) breaks.             |
|                        | Char. MOS-Short    | The MOSFET of the charge driver is short-circuited.                     |
|                        | No Input Power     | The input power is not connected successfully.                          |
|                        | Input vol. High    | The input voltage is very high.   |
|                        | Input vol. Low     | The input voltage is very low.  |
| Controller status      | Ctrler O. Temp.    | The controller is over-temperature.                                     |
| Communication status   | Comm. Timeout      | The communication is timeout.   |
| Battery Status         | Batt. O. Hi. Temp. | The battery is over high temperature.                                   |
|                        | Batt. O. Lo. Temp. | The battery is over low temperature.                                    |

|  |                  |   |
|--|------------------|---|
|  | Batt. I. R. Eorr | The internal resistance of the battery is in error.                               |
|  | Rated Vol Err.   | The rated voltage is in error.  |
|  | Batt. OVD        | The battery voltage exceeds the over voltage disconnect (OVD) voltage value.      |
|  | Batt. UVW        | The battery voltage is lower than the under voltage warning (UVW) voltage value.  |
|  | Batt. LVD        | The battery voltage is lower than the low voltage disconnect (LVD) voltage value. |
|  | Batt. Err        | The battery type is in error.   |

## 4.12 Meter parameter

The meter's model, software, and hardware version could be checked via the meter parameter page. And the two parameters (Switch pages, Backlight) could be browsed and modified as well.



On the above anyone page, long-press  +  +  +  at the same time to enter the language selection page:

Meter Para.  
LangSel.: En

| Parameters | Default | Range  | Remark  |
|------------|---------|--------|---|
| Sw-Pages   | 0       | 0~120S | The automatic switchover inverter for real-time monitoring page |
| BKlight    | 20      | 0~999S | LCD backlight time  |
| LangSel.   | Cn      | Cn/En  | Switch the page display language between Chinese and English.   |

## 5 Technical Specifications

| Electrical Parameter    |                             |
|-------------------------|-----------------------------|
| Self-consumption        | Backlight ON<23mA           |
|                         | Backlight OFF<15mA          |
| Mechanical Parameter    |                             |
| Faceplate dimensions    | 98×98 mm                    |
| Frame dimensions        | 114×114 mm                  |
| Connector type          | RJ45                        |
| Cable length (m)        | Standard: 2m, Longest: 50 m |
| Net weight              | Simple package: 0.23 Kg     |
|                         | Standard package: 0.32kg    |
| Environmental Parameter |                             |
| Environment temperature | -20°C~+70°C                 |

### RJ45 pin definition:

| Pin No. | Definition         |
|---------|--------------------|
| 1       | +5~12V Power input |
| 2       | +5~12V Power input |
| 3       | RS485-B            |
| 4       | RS485-B            |
| 5       | RS485-A            |
| 6       | RS485-A            |
| 7       | GND                |
| 8       | GND                |

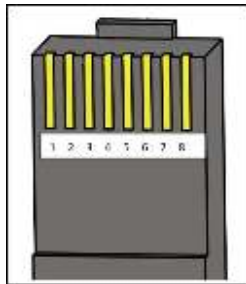

Data cable pin definitions

# Appendix Dimensions

Unit (mm)

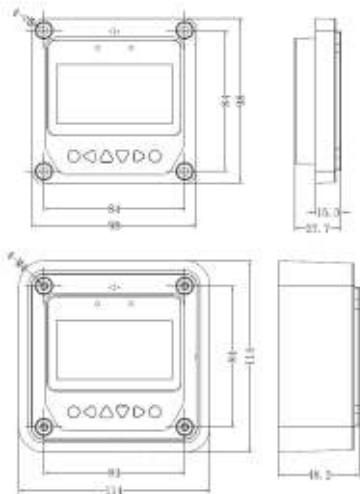

**Any changes without prior notice!** Version number: V3.5

**HUIZHOU EPEVER TECHNOLOGY CO., LTD.**

**Tel: +86-752-3889706**

**E-mail: [info@epever.com](mailto:info@epever.com)**

**Website: [www.epever.com](http://www.epever.com)**